

Assembly Instruction

Special Features:

- Length: 270, 300, 350, 400, 450, 500, 550mm.
- The drawer side-board is 88mm high.
- Drawer width can be designed freely with automatic error adjustment.
- Hidden full pullout silencing sliding skid can bear 40kg and enjoys
- excellent stability and quite and smooth sliding performance.
- Quick installation and dismantle.
- Newly-designed built-in damper is free from reinstallation and ensures soft and smooth drawer movements.

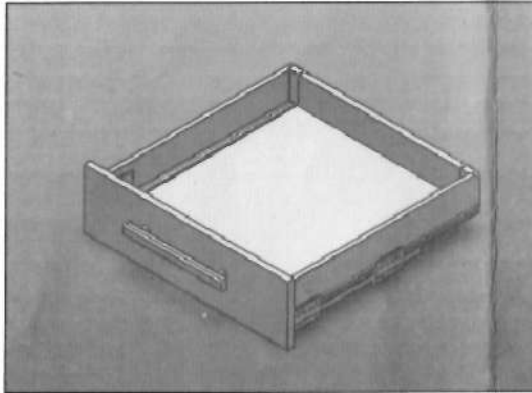

Basic length	Internally usable drawer depth	Minimum installation depth of drawer	Minimum installation height
300mm	274mm	300mm	110mm
350mm	324mm	350mm	110mm
400mm	374mm	400mm	110mm
450mm	424mm	450mm	110mm
500mm	474mm	500mm	110mm
550mm	524mm	550mm	110mm

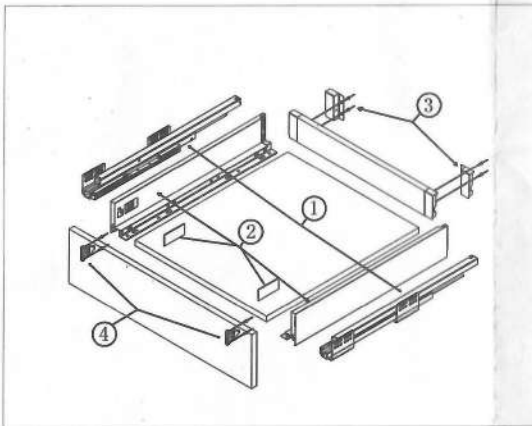

Technology pivot: Bottom and Back Panel Measurement 16MM Density Panel

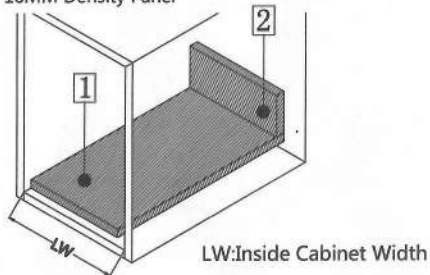

- 1** Bottom panel width=Inside Cabinet Width-75±0.5
Bottom panel length=Runner length-10MM
- 2** Back panel height= 68MM
Back panel width=Inside Cabinet Width-87±0.5

Runner Installation(mm)

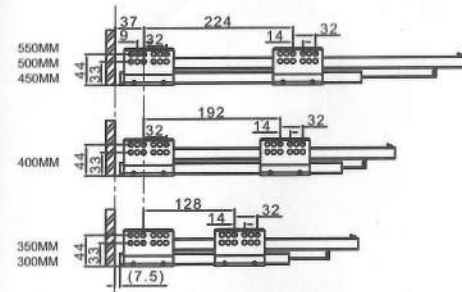

Basic length: 300/350/400/450/500/550

Inside Cabinet Dimension

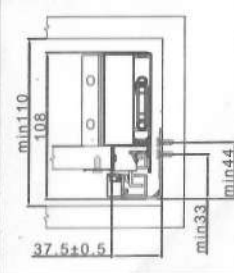

Front Panel Mounting Positions



Front Fixing Brackets Positions

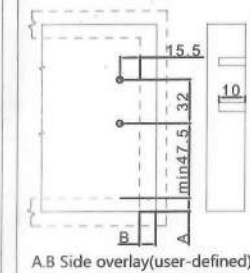

Back Panel Mounting Positions

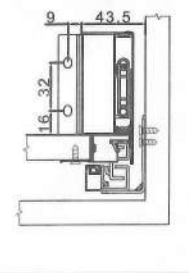

Front fixing brackets mounting

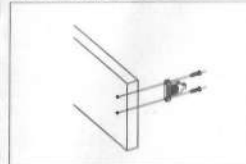

Front panel removing

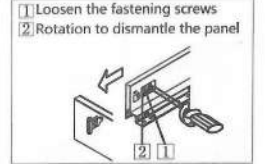
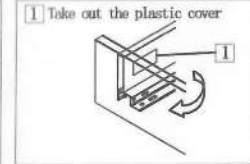

Front panel height adjustment : ±2mm

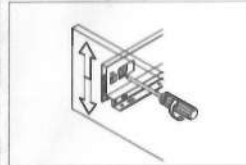

Front panel side adjustment : right1mm

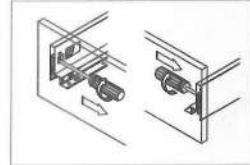

Front panel side adjustment : left1mm

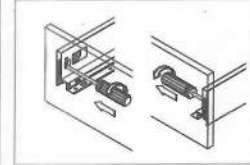

Mounting the drawer

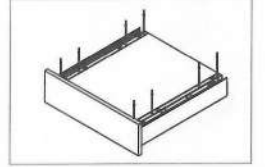
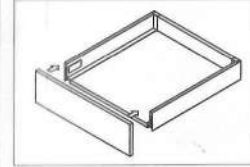
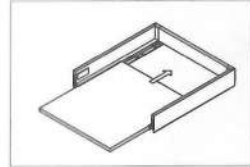
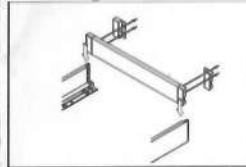

Installing the drawer

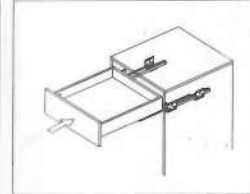
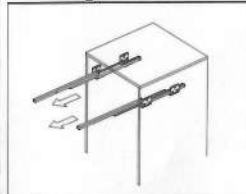

Removing the drawer

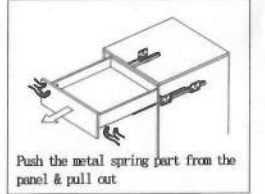

Push the metal spring part from the panel & pull out

Function of the damper

